

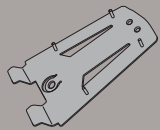







# SR2102 - KR2102

PORTAPACCO SPECIFICO - SPECIFIC HOLDER - PORTE-PAQUET SPÉCIFIQUE - SPEZIFISCHER TRÄGER - PORTA-EQUIPAJE ESPECÍFICO

## YAMAHA XENTER 125-150 (2012)

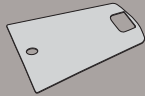
N°	Descrizione	Caratteristiche	Codice	Quantità	
1	Supporto - Support - Support Halterung - Soporte	-	GL2053	1	
2	Supporto - Support - Support Halterung - Soporte		GL2054	1	
3	Vite - Screw Vis - Schraube Tornillo	TSCEI M8x40	-	1	
4	Vite - Screw Vis - Schraube Tornillo	TSCEI M6x24		2	
5	Distanziale - Spacer Entretoise - Distanzstueck Distanciador	Ø18x8 foro 8.5mm	V225	2	
6	Distanziale - Spacer Entretoise - Distanzstueck Distanciador	Ø22x12 foro 12.5mm	V633	1	
7	Protezioni In Gomma Protective Rubber Pads Protections En Caoutchouc Schutzgummis Goma Protectora	-	Z2166	1	
8	Protezioni In Gomma Protective Rubber Pads Protections En Caoutchouc Schutzgummis Goma Protectora		Z2167	1	
9	Particolari Inclusi Nel Kit Viteria Della Piastra Components Included In The Fitting Kit Of The Plate Pièces Inclues Dans Le Kit De Vis De La Platine Die Einzelnen Teile Sind Bei Montagekit Der Platte Enthalten Despieces Incluidos En El Kit De Anclajes De La Parrilla				



# SR2102 - KR2102

PORTAPACCO SPECIFICO - SPECIFIC HOLDER - PORTE-PAQUET SPÉCIFIQUE - SPEZIFISCHER TRÄGER - PORTA-EQUIPAJE ESPECÍFICO

## YAMAHA XENTER 125-150 (2012)

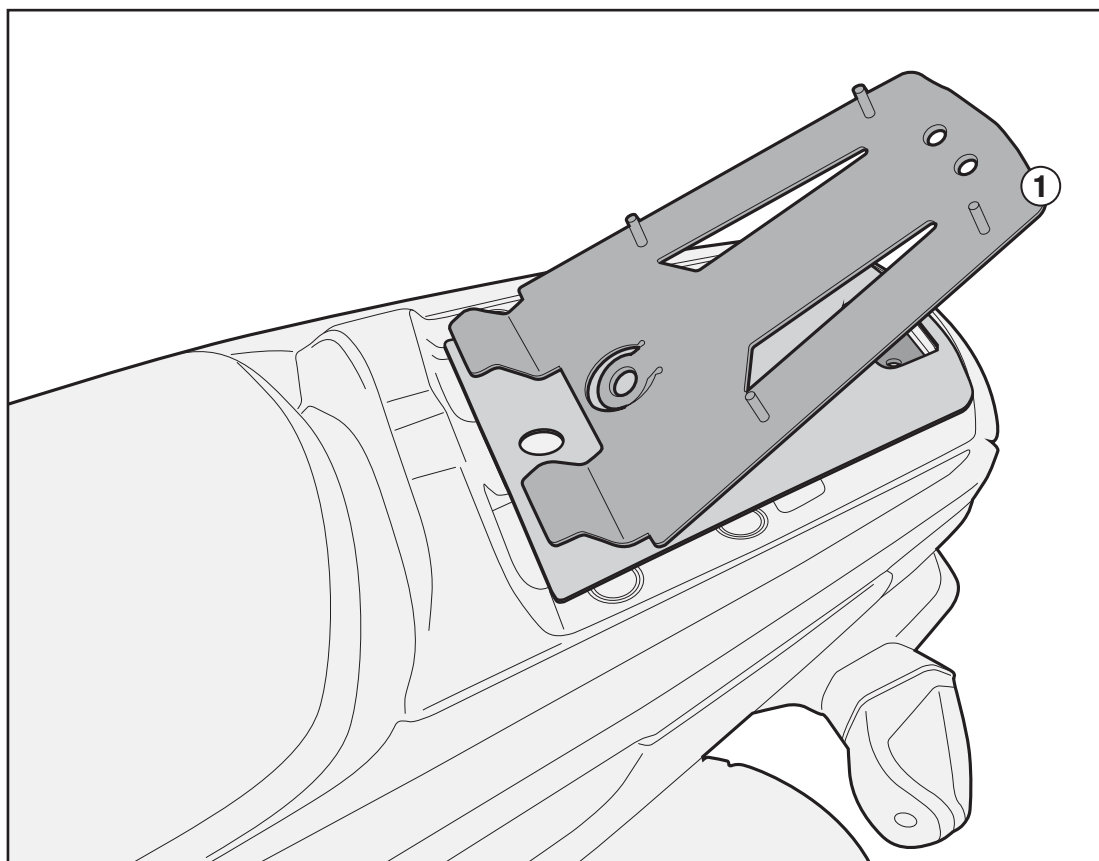
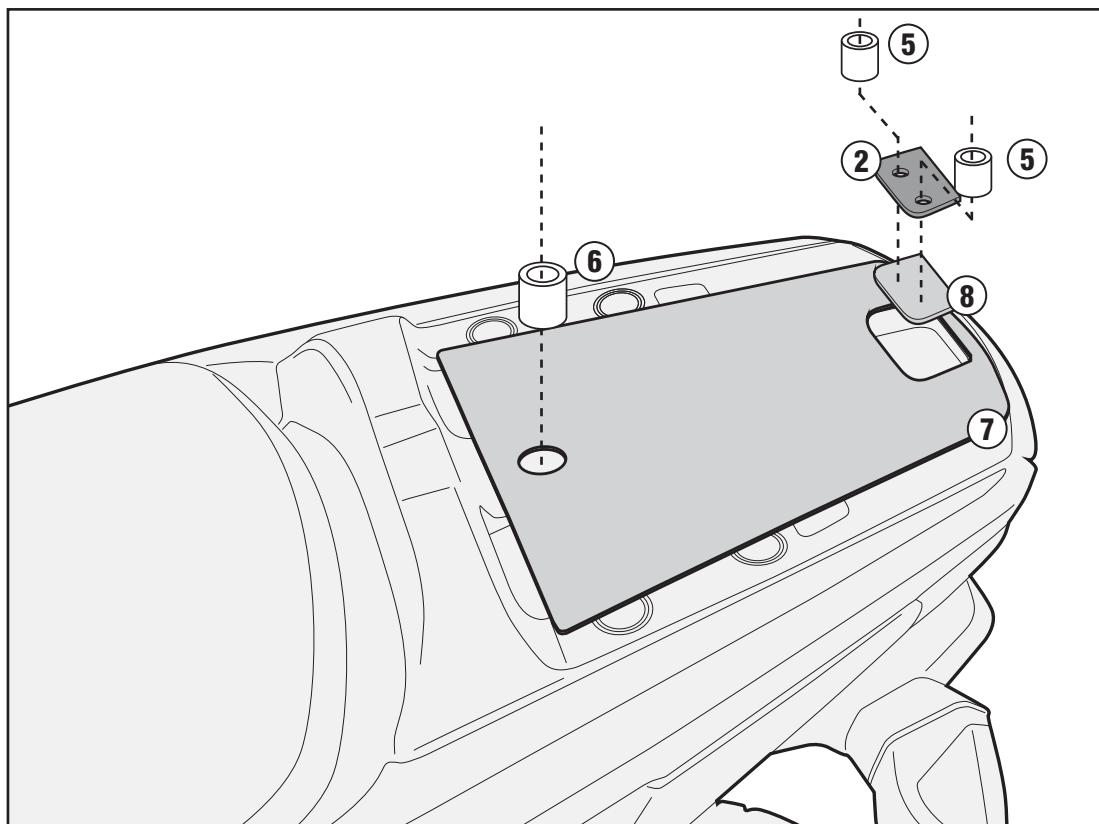

# SR2102 - KR2102

PORTAPACCO SPECIFICO - SPECIFIC HOLDER - PORTE-PAQUET SPÉCIFIQUE - SPEZIFISCHER TRÄGER - PORTA-EQUIPAJE ESPECÍFICO

## YAMAHA XENTER 125-150 (2012)

ATTENZIONE: CARICO MASSIMO 6Kg

WARNING: MAX LOAD, 6Kg.

ATTENTION: CHARGE MAXIMUM, 6Kg.

ACHTUNG: MAX, 6Kg.

¡ATENCIÓN!: CARGA MÁXIMA, 6Kg.

